

# Aesculap Power Systems

... get the speed you need.



Catalogue 2009

# Aesculap Power Systems

Aesculap – pioneer in the field of surgical power systems.

Aesculap introduced its first surgical electric motor as early as 1904. Further important milestones followed in subsequent decades with the introduction of compressed-air systems in the 1960s, the further development of flexible cable electric motors in the 1970s, the introduction of battery-driven motors in the 1980s and the development of pneumatic and electric high speed systems in the 1990s.

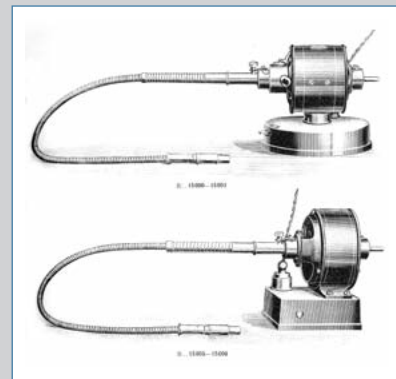
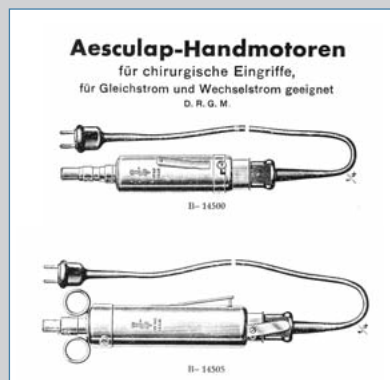

With the current systems Acculan® 3Ti, HiLAN® XS and microspeed® uni, Aesculap offers you customised solutions for virtually all fields of application. Our system range is completed by the innovative Eccos® storage system which enables timely, mechanical reprocessing of your Aesculap power systems.

## Aesculap Power Systems

....get the speed you need.

## How the catalogue works

### 1. Select motor system



**GD676** **GB578R**

**microspeed® uni Hi 150**  
 High speed motor for all Hi-Line and Hi-Line XS handpieces  
 150 W; 10.000 – 80.000 1/min;  
 ⤴; 3,5 Ncm; 99 x 27 mm;  
 155 g

•••▶ **Hi-Line, Hi-Line XS**

indicates handpiece compatibility

Electric

### 2. Select handpiece & Eccos® holder



**GB756R** **GB614R**

**Hi-Line XS handpiece**  
 1 ring code;  
 spray nozzle GB761SU (not included)

article code Eccos® fixation

Hi-Line XS

### 3. Select Tool

Use Burrs & Blades catalogue 017599

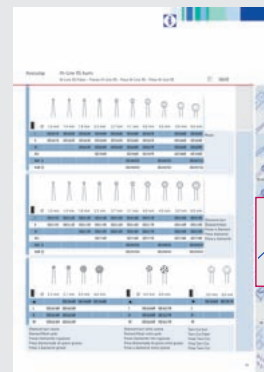
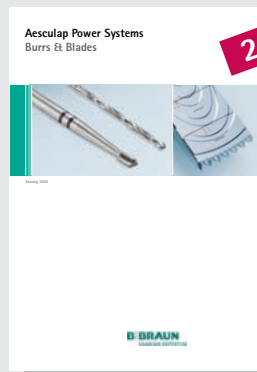

Chapter  
 Hi-Line XS  
 burrs





# Content

## Power Systems

- **Electric Power Systems**
  - microspeed® uni
  - microspeed® arthro
  - Elan® EC
- **Pneumatic Power Systems**
  - HiLAN® XS
- **Battery Power Systems**
  - Acculan® 3Ti

## Handpieces

- **Hi-Line XS**
- **micro-Line**
- **mini-Line**

## Accessories

## Processing

- **Sterilit® Power Systems**
- **Eccos®**

## Index/Signs and Symbols



# Power Systems

## Electric Power Systems

- **microspeed<sup>®</sup> uni**
- **microspeed<sup>®</sup> arthro**
- **Elan<sup>®</sup> EC**

## Pneumatic Power Systems

- **HiLAN<sup>®</sup> XS**

## Battery Power Systems

- **Acculan<sup>®</sup> 3Ti**

# Electric Power Systems microspeed<sup>®</sup> uni



## The electric power system of the future

- > The perfect system for neurotology, neurosurgery and spine
- > Versatile system for small bone surgery and arthroscopy
- > Reliable and durable due to the application of top-grade material and state-of-the art technology
- > Easy operation over touch screen and function control button
- > Compatible with handpiece lines Hi-Line XS, Hi-Line, micro-Line and mini-Line





**GD670**

**microspeed® uni control unit** with irrigation pump; touch screen; power cord not included; pump flow 0 - 80 ml/min  
100-240 V AC, 50/60Hz;  
305 x 305 x 175 mm; 8.300 g  
consisting parts:  
GD412804 bottle holder



**GD671**

**microspeed® uni foot control** double pedal; protection type IPx8; anaesthetic proof class M  
5.0 m;  
250 x 225 x 75 mm; 2.390 g;  
Latex



**GD673**



**microspeed® uni motor cable** with hand control; for use with motors GD674, GD676, GD678, GD685  
3.0 m; 380 g; Latex



**GD668**

**microspeed® uni foot control** single pedal; protection type IPx8; anaesthetic proof class M  
5.0 m;  
250 x 225 x 75 mm; 2.420 g;  
Latex



**GD672**



**microspeed® uni motor cable** for use with motors GD674, GD676, GD678, GD685  
3.0 m; 360 g; Latex



**GD676**

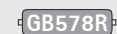

**microspeed® uni Hi 150** high speed motor for all Hi-Line and Hi-Line XS handpieces  
150 W; 10.000 - 80.000 1/min;  
3.5 Ncm; 99 x 27 mm;  
155 g

•••▶ **Hi-Line, Hi-Line XS**

consisting parts:  
GB600820 Sterilit spray adaptor Hi

Electric

Electric

Electric

Electric

Electric

Electric

# microspeed® uni



GD675 GB586R

**microspeed® uni XS Hi**  
high speed motor for all Hi-Line XS handpieces

115 W; 10.000 - 80.000 1/min;  
↖ ↗; 2.6 Ncm; 76 x 18 mm;  
📦 80 g; Latex

••• ▶ **Hi-Line XS**

consisting parts:  
GB600870 Sterilit spray adaptor XS  
GB600820 Sterilit spray adaptor Hi



GD678 GB578R

**microspeed® uni micro 150**  
low speed motor for all micro-Line handpieces

150 W; 1.000 - 30.000 1/min;  
↖ ↗; 7.0 Ncm; 113 x 27 mm;  
📦 161 g

••• ▶ **micro-Line**

consisting parts:  
GB600810 Sterilit spray adaptor micro-Line  
GB600820 Sterilit spray adaptor Hi



GD684 GB579R

**microspeed® uni pistol handpiece**  
low speed pistol for all mini-Line handpieces except of GB373R, GB374R, GB385R, GB397R;

oscillation and tapping mode  
100 W; 1.000 - 16.000 1/min;  
↖ ↗; 7.0 Ncm; 📏 2.5 mm;  
📏 3.0 m; 95 x 27 x 120 mm;  
📦 480 g; Latex

••• ▶ **mini-Line**

consisting parts:  
GB600830 Sterilit spray adaptor mini-Line  
GD684225 K-wire protection sleeve



GD685 GB587R

**microspeed® uni perforator driver**  
to use with cranial perforators with Hudson shank

150 W; 650 - 800 1/min; ↖ ↗;  
3.0 Nm; 155 x 41 mm; 📦 530 g

consisting parts:  
GB600820 Sterilit spray adaptor Hi



GD674 GB578R

**microspeed® uni mini 100**  
low speed motor for all mini-Line handpieces except of GB385R, GB388R, GB397R, GB398R

100 W; 1.000 - 16.000 1/min;  
↖ ↗; 7.0 Ncm; 95 x 27 mm;  
📦 176 g

••• ▶ **mini-Line**

consisting parts:  
GB600820 Sterilit spray adaptor Hi  
GB600830 Sterilit spray adaptor mini-Line



GD681 GB580R

**microspeed® uni shaver handpiece**  
with hand control; for Aesculap shaver tips; variable suction; automatic tip recognition;

oscillation speed adjustable 0.3 - 2.0 seconds

100 W; 400 - 8.000 1/min; ↖ ↗;  
📏 3.0 m; 150 x 27 x 37 mm;  
📦 510 g; Latex

consisting parts:  
GB600820 Sterilit spray adaptor Hi



GD682

GB580R

**microspeed® uni shaver handpiece**

for Aesculap shaver tips; variable suction; automatic tip recognition; oscillation speed adjustable 0.3 - 2.0 seconds; to be used in combination with foot control GD671

100 W; 400 - 8.000 1/min; ;

 3.0 m; 150 x 27 x 37 mm;

 510 g; 

consisting parts:

GB600820 Sterilit spray adaptor Hi

Power cords, irrigation sets and trolleys see 'Accessories'

Electric

Electric

Electric

Electric

Electric

Electric

# Electric Power Systems microspeed<sup>®</sup> arthro



## **The optimal system for arthroscopy and small bone surgery**

- > Reliability and durability due to the application of top-grade material and state-of-the-art manufacturing technology
- > Shaver handpieces available with ergonomic two button hand control or with foot control
- > Compact and lightweight construction, with automatic tip recognition
- > Individual adjustment of oscillation frequency and acceleration and stopping characteristics
- > Large range of shaver tips and burrs for excellent cutting and ablation performance



**GD665**

**microspeed® arthro control unit**  
touch screen; power cord not included  
100–240 V AC, 50/60Hz;  
305 x 305 x 175 mm; 5.300 g



**GD671**

**microspeed® uni foot control**  
double pedal; protection type IPx8;  
anaesthetic proof class M  
↔ 5.0 m;  
250 x 225 x 75 mm; 2.390 g;  
 Latex



**GD672**

**GB689R**

**microspeed® uni motor cable**  
for use with motors GD674,  
GD676, GD678, GD685  
↔ 3.0 m; 360 g; Latex



**GD673**

**GB689R**

**microspeed® uni motor cable**  
with hand control; for use with  
motors GD674, GD676, GD678,  
GD685  
↔ 3.0 m; 380 g; Latex



**GD681**

**GB580R**

**microspeed® uni shaver handpiece**  
with hand control; for Aesculap  
shaver tips; variable suction;  
automatic tip recognition;  
oscillation speed adjustable 0.3 –  
2.0 seconds  
100 W; 400 – 8.000 1/min; ↔;  
↔ 3.0 m; 150 x 27 x 37 mm;  
510 g; Latex  
consisting parts:  
GB600820 Sterilit spray adaptor Hi



**GD682**

**GB580R**

**microspeed® uni shaver handpiece**  
for Aesculap shaver tips; variable  
suction; automatic tip recognition;  
oscillation speed adjustable 0.3 –  
2.0 seconds; to be used in  
combination with foot control  
GD671  
100 W; 400 – 8.000 1/min; ↔;  
↔ 3.0 m; 150 x 27 x 37 mm;  
510 g; Latex  
consisting parts:  
GB600820 Sterilit spray adaptor Hi

Electric

Electric

Electric

Electric

Electric

Electric

# microspeed® arthro



GD684

GB579R

**microspeed® uni pistol handpiece**

low speed pistol for all mini-Line handpieces except of GB373R, GB374R, GB385R, GB397R;  
oscillation and tapping mode  
100 W; 1.000 - 16.000 1/min;  
↻; 7.0 Ncm; ⌀ 2.5 mm;  
— 3.0 m; 95 x 27 x 120 mm;  
🗑 480 g; Latex

•••▶ **mini-Line**

consisting parts:  
GB600830 Sterilit spray adaptor mini-Line  
GD684225 K-wire protection sleeve



GD678

GB578R

**microspeed® uni micro 150**

low speed motor for all micro-Line handpieces  
150 W; 1.000 - 30.000 1/min;  
↻; 7.0 Ncm; 113 x 27 mm;  
🗑 161 g

•••▶ **micro-Line**

consisting parts:  
GB600810 Sterilit spray adaptor micro-Line  
GB600820 Sterilit spray adaptor Hi



GD674

GB578R

**microspeed® uni mini 100**

low speed motor for all mini-Line handpieces except of GB385R, GB388R, GB397R, GB398R  
100 W; 1.000 - 16.000 1/min;  
↻; 7.0 Ncm; 95 x 27 mm;  
🗑 176 g

•••▶ **mini-Line**

consisting parts:  
GB600820 Sterilit spray adaptor Hi  
GB600830 Sterilit spray adaptor mini-Line

Power cords, irrigation sets and trolleys see 'Accessories'



# Electric Power Systems

## Elan<sup>®</sup> EC



### The universal power system for all disciplines:

- > Unlimited power
- > Legendary reliability and durability
- > Easy handling
- > More than 15.000 systems installed worldwide





**GA830**

**Elan® EC control unit**  
power cord not included  
100-240 V AC, 50/60Hz;  
305 x 305 x 125 mm; 7.300 g



**GA835**

**Elan® EC control unit**  
with irrigation pump; power cord  
not included  
100-240 V AC, 50/60Hz;  
305 x 305 x 125 mm; 7.900 g  
consisting parts:  
GD412804 bottle holder



**GA188**

**Foot control**  
waterproof (IP67) acc. to IEC601  
and DIN40050; anaesthetic proof  
class M  
5.0 m;  
130 x 200 x 60 mm; 1.900 g;  
 **Latex**



**GA176**

**GB680R**

**Flexible cable micro**  
for all micro-Line handpieces  
0 - 20.000 1/min; 1.8 m;  
600 g; **Latex**

●●▶ **micro-Line**

**GA173**

**GB680R**

**Flexible cable micro**  
for all micro-Line handpieces  
0 - 20.000 1/min; 2.3 m;  
700 g; **Latex**

●●▶ **micro-Line**

Electric

Electric

Electric

Electric

Electric

Electric

Power cords, irrigation sets and  
trolleys see 'Accessories'

# Pneumatic Power Systems

## HiLAN® XS



### **Power, reliability and flexibility.**

> HiLAN® XS, HiLAN®, microLAN® - Integration of high and low speed

> The system for all applications in microsurgery

recommended pressure for all pneumatic AESCULAP Systems is 6 - 10 bar, 85 - 145 psi (technical information at 6 bar)

## HiLAN® XS



GA740R GB610R

### HiLAN® XS

pneumatic high speed motor for all Hi-Line XS handpieces  
50 W; 0 - 90.000 1/min; ↗; 2.5 Ncm; 66 x 16 mm; 63 g

•••▶ Hi-Line XS

consisting parts:  
GB600820 Sterilit spray adaptor Hi



GA741R GB610R

### HiLAN® XS

pneumatic high speed motor with forward and reverse action for all Hi-Line XS handpieces  
50 W; 0 - 90.000 1/min; ↗↘; 2.5 Ncm; 66 x 16 mm; 67 g

•••▶ Hi-Line XS

consisting parts:  
GB600820 Sterilit spray adaptor Hi

## HiLAN®



GA529 GB559R

### HiLAN® with hand control

pneumatic high speed motor for all Hi-Line and Hi-Line XS handpieces  
50 W; 0 - 90.000 1/min; ↗; 2.5 Ncm; 80 x 19 mm; 132 g

•••▶ Hi-Line XS, Hi-Line

consisting parts:  
GB600820 Sterilit spray adaptor Hi



GA519 GB559R

### HiLAN®

pneumatic high speed motor for all Hi-Line and Hi-Line XS handpieces  
70 W; 0 - 80.000 1/min; ↗; 3.0 Ncm; 80 x 19 mm; 94 g

•••▶ Hi-Line XS, Hi-Line

consisting parts:  
GB600820 Sterilit spray adaptor Hi



GA742R GB609R

### HiLAN® perforator driver

with Hudson chuck  
130 W; 0 - 800 1/min; ↗; 3.6 Nm; 130 x 37 mm; 495 g

consisting parts:  
GB600820 Sterilit spray adaptor Hi

Pneumatic

Pneu-

Pneu-

Pneu-

Pneu-

Pneu-

# HiLAN® XS

## microLAN®



GA553 GB685R

### microLAN® 100

pneumatic motor for all micro-Line handpieces  
100 W; 0 - 20.000 1/min; ↗ ↘;  
8.0 Ncm; 95 x 22 mm; 📦 130 g

●●▶ micro-Line

consisting parts:  
GB600810 Sterilit spray adaptor  
micro-Line  
GB600820 Sterilit spray adaptor Hi



GA554 GB685R

### microLAN® 60 with hand control

pneumatic motor for all micro-Line handpieces, except of GB200, GB128R, GB129, GB130R, GB169R, GB231R, GB265R, GB268R  
60 W; 0 - 25.000 1/min; ↗ ↘;  
5.1 Ncm; 100 x 22 mm; 📦 100 g

●●▶ micro-Line

consisting parts:  
GB600810 Sterilit spray adaptor  
micro-Line  
GB600820 Sterilit spray adaptor Hi



# Battery Power Systems

## Acculan® 3Ti



**Acculan® 3Ti is the battery-operated power system for orthopaedics, traumatology, cardiothoracic surgery and dermatology.**

- > Powerfull – up to 250 Watt
- > Reliable – battery and control electronic are not sterilised
- > Easy handling – Titanium housing allows mechanical alkaline reprocessing

Acculan® 3Ti – the reinvention of battery power tools



**GA671** **GB495R**

**Acculan® 3Ti small drill**  
with oscillation and tapping  
mode; not for use with  
Acetabulum reamers

220 W; 4.0 mm;  
107 x 47 x 180 mm; 1.100 g

consisting parts:  
GA666 small NiMH battery  
GA675 lid  
GA678 sterile funnel  
GA672207 K-wire protection sleeve  
GA672211 rinsing adaptor



**GA672** **GB495R**

**Acculan® 3Ti drill and reamer**  
250 W; 4.0 mm;  
107 x 47 x 200 mm; 1.250 g

consisting parts:  
GA675 lid  
GA676 NiMH battery  
GA678 sterile funnel  
GA672207 K-wire protection sleeve  
GA672211 rinsing adaptor



**GB630R** **GB496R**

**Acculan® 3Ti drill attachment**  
with Zimmer/Hudson chuck

0 - 1.000 1/min; 5.0 Nm;  
 4.0 mm; 100 x 39 mm;  
 263 g



**GB638R** **GB496R**

**Acculan® 3Ti drill attachment**  
with Jacobs chuck 0 - 6.5 mm

0 - 1.000 1/min; 5.0 Nm;  
 4.0 mm; 105 x 39 mm;  
 333 g

consisting parts:  
GA031R key



**GB635R** **GB496R**

**Acculan® 3Ti drill attachment**  
with small AO chuck

0 - 1.000 1/min; 5.0 Nm;  
 4.0 mm; 90 x 39 mm; 246 g



**GB643R** **GB496R**

**Acculan® 3Ti K-wire attachment**  
for K-wires from 0.6 to 4.0 mm

0 - 1.000 1/min;  
93 x 36 x 137 mm; 300 g

Battery

Battery

Battery

Battery

Battery

Battery

# Acculan® 3Ti



**GB636R** **GB496R**  
**Acculan® 3Ti drill attachment**  
 with Aesculap hexagonal chuck  
 0 - 1.000 1/min; 5.0 Nm;  
 4.0 mm; 93 x 39 mm; 253 g



**GB645R** **GB496R**  
**Acculan® 3Ti drill attachment**  
 for Synthes radiolucent drive  
 511.300  
 0 - 900 1/min; 110 x 35 mm;  
 225 g



**GB654R** **GB496R**  
**Acculan® 3Ti reamer attachment**  
 with Harris chuck  
 0 - 250 1/min; 19.0 Nm;  
 4.0 mm; 106 x 39 mm;  
 323 g



**GB655R** **GB496R**  
**Acculan® 3Ti reamer attachment**  
 with large AO chuck  
 0 - 250 1/min; 19.0 Nm;  
 4.0 mm; 107 x 39 mm;  
 334 g



**GB656R** **GB496R**  
**Acculan® 3Ti reamer attachment**  
 with Zimmer/Hudson chuck  
 0 - 250 1/min; 19.0 Nm;  
 4.0 mm; 118 x 39 mm;  
 344 g



**GB660R** **GB496R**  
**Acculan® 3Ti sagittal saw**  
**attachment**  
 for Acculan® 3Ti rapid action saw  
 blades with a maximum useable  
 length of 50 mm  
 0 - 17.000 1/min; 4°47';  
 89 x 36 x 44 mm; 270 g





**GA673** **GB495R**

**Acculan® 3Ti oscillating saw**  
250 W; «↔» 0 - 15.000 1/min;  
∠ 4°47'; 107 x 47 x 200 mm;  
⚖ 1.600 g  
consisting parts:  
GA675 lid  
GA676 NiMH battery  
GA678 sterile funnel



**GA668** **GB498R**

**Acculan® 3Ti straight oscillating saw**  
250 W; «↔» 0 - 15.000 1/min;  
∠ 4°47'; 288 x 54 x 74 mm;  
⚖ 1.500 g  
consisting parts:  
GA675 lid  
GA676 NiMH battery  
GA678 sterile funnel



**GA670** **GB498R**

**Acculan® 3Ti dermatome**  
width keyless adjustable; thickness adjustable (1/10 mm steps); cutting thickness: 0.2 - 1.2 mm; cutting width: max. 78 mm; suitable blades GB228R (to be ordered separately)  
220 W; «↔» 0 - 6.500 1/min;  
∠ 3.1 mm; 290 x 110 x 90 mm;  
⚖ 1.700 g  
consisting parts:  
GA666 small NiMH battery  
GA675 lid  
GA678 sterile funnel



**GA674** **GB495R**

**Acculan® 3Ti reciprocating saw**  
250 W; «↔» 0 - 15.000 1/min;  
∠ 3.2 mm; 180 x 47 x 200 mm;  
⚖ 1.540 g  
consisting parts:  
GA675 lid  
GA676 NiMH battery  
GA678 sterile funnel  
GB440215 cleaning plate



**GB436R** **GB686R**

**Protection guide**  
for use with GA674 and saw blade GC761R



**GA677**

**Acculan® 3Ti charger**  
for Acculan® 3Ti batteries GA666 and GA676; 4 charging bays; avoids memory effect; automatic battery diagnosis function; with optional available charging bay GA677830 also compatible to Acculan® II batteries GA616, GA626 and GA646; power cord not included  
100-240 V AC, 50/60Hz;  
440 x 140 x 180 mm; ⚖ 3.500 g

Battery

Battery

Battery

Battery

Battery

Battery

# Acculan® 3Ti



**GA666**

**Acculan® 3Ti small NiMH battery**  
only for GA670 and GA671; with  
integrated electronic motor  
control  
9,6V ; 1,05Ah  
120 x 43 x 50 mm; 304 g



**GA676**

**Acculan® 3Ti NiMH battery**  
only for GA668, GA672, GA673,  
GA674;  
with integrated electronic motor  
control  
9,6V ; 1,95Ah  
140 x 43 x 50 mm; 425 g



**GA675**

**GB487R**

**Acculan® 3Ti lid**



**GA678**

**GB488R**

**Acculan® 3Ti sterile funnel**



**GA679**

**GB489R**

**Acculan® 3Ti battery removal  
device**

# Handpieces

Hi-Line XS

micro-Line

mini-Line

# Hi-Line XS handpieces

## Straight Hi-Line XS handpieces for the Hi-Line XS burr range



**GB751R** **GB614R**

**Hi-Line XS handpiece, straight**  
1 ring code;  
spray nozzle GB761SU (not included)



**GB752R** **GB614R**

**Hi-Line XS handpiece, straight**  
2 ring code;  
spray nozzle GB762SU (not included)



**GB753R** **GB614R**

**Hi-Line XS handpiece, straight**  
3 ring code;  
spray nozzle GB763SU (not included)

## Angled Hi-Line XS handpieces for the Hi-Line XS burr range



**GB756R** **GB614R**

**Hi-Line XS handpiece, angled**

1 ring code;  
spray nozzle GB761SU (not included)



**GB757R** **GB614R**

**Hi-Line XS handpiece, angled**

2 ring code;  
spray nozzle GB762SU (not included)



**GB758R** **GB614R**

**Hi-Line XS handpiece, angled**

3 ring code;  
spray nozzle GB763SU (not included)

Hi-Line XS

Hi-Line XS

Hi-Line XS

Hi-Line XS

Hi-Line XS

Hi-Line XS

# Hi-Line XS handpieces

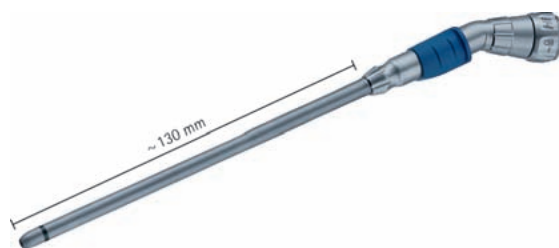

GB771R GB614R

**Hi-Line XS handpiece, angled**  
extra long XL1;  
1 bold ring code;  
spray nozzle GB764SU (not  
included)

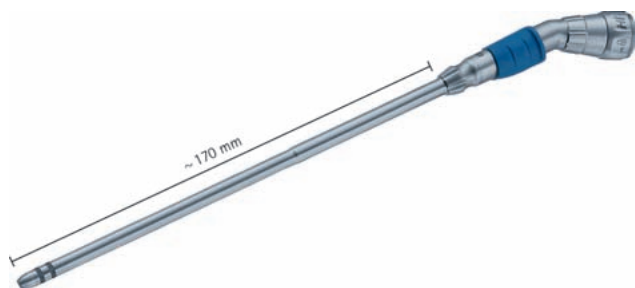

GB772R GB614R

**Hi-Line XS handpiece, angled**  
extra long XL2;  
2 bold ring code;  
spray nozzle GB765SU (not  
included)

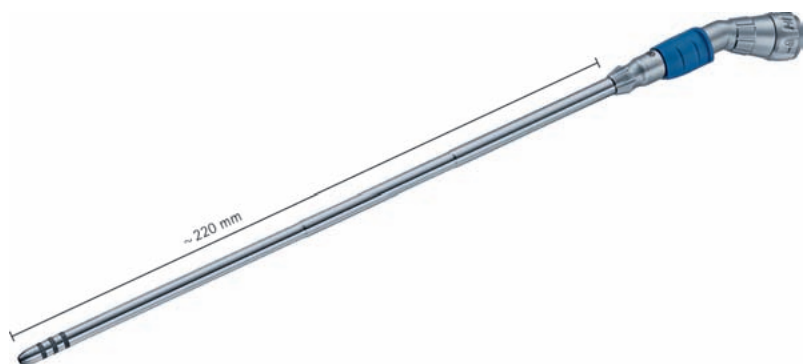

GB773R GB614R

**Hi-Line XS handpiece, angled**  
extra long XL3;  
3 bold ring code;  
spray nozzle GB766SU (not  
included)



**GB740R** **GB614R**

**Hi-Line XS craniotome and multi purpose handpiece**

to be used with dura guards, drill depth guard and holding sleeve  
GB741R - GB748R,  
spray nozzle GB767SU (not included)



**GB741R** **GB615R**

**Hi-Line XS dura guard**

fixed;  
1 ring code;  
to be used with craniotome burr  
GE420R, GE420SU, GE429SU



**GB742R** **GB615R**

**Hi-Line XS dura guard**

fixed;  
2 ring code;  
to be used with craniotome burr  
GE520R, GE520SU, GE529SU



**GB743R** **GB615R**

**Hi-Line XS dura guard**

fixed;  
3 ring code;  
to be used with craniotome burr  
GE620R, GE620SU, GE629SU



**GB746R** **GB615R**

**Hi-Line XS dura guard**

steerable;  
1 ring code;  
to be used with craniotome burr  
GE420R, GE420SU, GE429SU



**GB747R** **GB615R**

**Hi-Line XS dura guard**

steerable;  
2 ring code;  
to be used with craniotome burr  
GE520R, GE520SU, GE529SU

Hi-Line XS

Hi-Line XS

Hi-Line XS

Hi-Line XS

Hi-Line XS

Hi-Line XS

# Hi-Line XS handpieces



**GB748R** 

**Hi-Line XS dura guard**  
steerable;  
3 ring code;  
to be used with craniotome burr  
GE620R, GE620SU, GE629SU



**GB745R** 

**Hi-Line XS holding sleeve**  
for craniotome handpiece and  
multipurpose handpiece GB740R



**GB744R** 

**Hi-Line XS drill depth guard**  
for craniotome handpiece and  
multipurpose handpiece GB740R  
2 - 8 mm





# micro-Line handpieces

For burrs with shank diameter of 2,35 mm



**GB109**

**GB681R**

**micro-Line handpiece**  
coding: 1 blue ring;  
for 51 mm burrs  
1:1; 81 mm



**GD450M**

**GB681R**

**micro-Line handpiece**  
coding: 1 blue ring;  
for 70 mm burrs;  
suitable spray nozzle GD460R (not  
included)  
1:1; 97 mm



**GD451M**

**GB681R**

**micro-Line handpiece**  
coding: 1 blue ring;  
for 95 mm burrs;  
suitable spray nozzle GD461R (not  
included)  
1:1; 127 mm

For burrs with shank diameter of 2,35 mm; angulation 21°



**GD455M** **GB681R**

**micro-Line handpiece, angled**

coding: 1 red ring;  
for 70 mm burrs;  
suitable spray nozzle GD460R (not  
included)

1:2; 120 mm



**GD456M** **GB681R**

**micro-Line handpiece, angled**

coding: 1 red ring;  
for 95 mm burrs;  
suitable spray nozzle GD461R (not  
included)

1:2; 150 mm



**GD457M** **GB681R**

**micro-Line handpiece, angled**

coding: 1 red ring;  
for 125 mm burrs;  
suitable spray nozzle GD462R (not  
included)

1:2; 180 mm

micro-Line

micro-

micro-

micro-

micro-

micro-

# micro-Line handpieces

For use with micro-inserts with imperator gearing, angulation 21°



**GB114R** **GB681R**  
**micro-Line handpiece**  
 coding: 1 red ring;  
 suitable spray nozzle GB117R (not included)  
 1:2; 77 mm



**GB111** **GB681R**  
**micro-Line handpiece**  
 coding: 1 green ring;  
 suitable spray nozzle GB117R (not included)  
 4:1; 74 mm



**GB113** **GB681R**  
**micro-Line handpiece**  
 coding: 2 green rings;  
 suitable spray nozzle GB117R (not included)  
 30:1; 74 mm



**GB173** **GB690R**  
**Imperator attachment**  
 for burs with 2.35 mm diameter;  
 up to 70 mm length; minimal shaft length 30 mm; spray nozzle GB117R (not included)  
 1:1; 43 mm

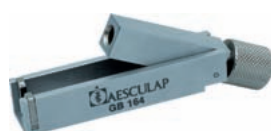

**GB164**  
**Mounting tool**  
 for imperator attachment GB173



**GB119** **GB690R**  
**Contra angle head**  
 coding: 1 green dot;  
 for tools with Dental shank  
 2:1; 43 mm



**GD305** **GB681R**  
**micro-Line reciprocating saw**  
 keyless; suitable spray nozzle  
 GD306R (not included)  
 2,5:1;  $\llcorner\llcorner\llcorner$  8.000 1/min;  
 $\updownarrow$  1.3 mm;  $\text{♁}$  48 g  
 consisting parts:  
 GD320R saw blade



**GD307** **GB681R**  
**micro-Line sagittal saw**  
 with captive nut; suitable spray  
 nozzle GD308R (not included)  
 1:1;  $\llcorner\llcorner\llcorner$  20.000 1/min;  $\sphericalangle$  7°;  
 $\text{♁}$  50 g  
 consisting parts:  
 GD372206 key



**GB129** **GB682R**  
**micro-Line sagittal saw**  
 spray nozzle GA222R (not  
 included)  
 1:1;  $\llcorner\llcorner\llcorner$  20.000 1/min;  
 $\sphericalangle$  4°46';  $\text{♁}$  345 g  
 consisting parts:  
 TE472 ring spanner  
 GB125804 nut



**GB128R** **GB682R**  
**micro-Line transversal saw**  
 suitable spray nozzle GA221R (not  
 included)  
 1:1;  $\llcorner\llcorner\llcorner$  20.000 1/min;  
 $\sphericalangle$  10°24';  $\text{♁}$  385 g  
 consisting parts:  
 GB020R allen key



**GB200** **GB682R**  
**micro-Line drill pistol**  
 spray nozzle GA221R (not  
 included)  
 $\sphericalangle$  20:1;  $\text{♁}$  2.7 mm;  $\text{♁}$  700 g



**GB130R** **GB682R**  
**micro-Line reciprocating saw**  
 suitable spray nozzle GA223R (not  
 included)  
 1:1;  $\llcorner\llcorner\llcorner$  20.000 1/min;  $\updownarrow$  3.0 mm;  
 $\text{♁}$  310 g

# micro-Line handpieces



**GB222**

**Jacobs chuck**  
Ø 0 - 4 mm  
consisting parts:  
GA062R key



**GB223**

**Jacobs chuck**  
Ø 0 - 6.5 mm  
consisting parts:  
GA031R key



**GB224**

**Small AO chuck**



**GB227R**

**K-wire driver**  
for K-wires from 0.6 to 2.5 mm



**GB865**

**micro-Line motor chisel**  
for chisels GD905R-GD947R  
1:1; 216 g



**GB169R**

**micro-Line drill**  
for exchangeable chucks; suitable  
spray nozzle GA228R (not  
included)  
20:1; 280 g  
consisting parts:  
GC523200 ring spanner

**GB682R**



**GB106R**  
Hudson chuck



**GB268R** **GB682R**  
**micro-Line craniotome**  
with fixed duraguard  
1:1;  $\updownarrow$  200 g  
consisting parts:  
GB267R handpiece  
GB298R fixed dura-guard  
GC303R burr



**GB231R** **GB682R**  
**micro-Line Dermatome acc. to Wagner**  
cutting width keyless adjustable;  
thickness adjustable (1/10 mm steps);  
cutting thickness: 0.2 - 1.2 mm;  
cutting width: max. 78 mm  
6:1;  $\updownarrow$  3.0 mm;  $\updownarrow$  770 g  
consisting parts:  
GB228R blades



**GB265R** **GB682R**  
**micro-Line craniotome**  
with turnable duraguard  
1:1;  $\updownarrow$  200 g  
consisting parts:  
GB266M turnable dura-guard  
GB267R handpiece  
GC303R burr



**GB292** **GB681R**  
**micro-Line pediatric craniotome, Freiburg pattern**  
with fixed duraguard  
1:1;  $\updownarrow$  100 g  
consisting parts:  
GB109 handpiece  
GB291R dura-guard  
GC304R burr

# mini-Line handpieces

## mini-Line



**GB376R** **GB673R**  
**mini-Line burr attachment**  
 straight; for 2,35 mm shank; for  
 burs up to 70mm length; suitable  
 spray nozzle GB378 (not included)  
 1:2; 108 g



**GB382R** **GB673R**  
**mini-Line drill attachment**  
 for tools with AO shank; suitable  
 spray nozzle GB378 (not included)  
 16:1; 98 g



**GB383R** **GB673R**  
**mini-Line drill attachment**  
 Jacobs chuck; suitable spray nozzle  
 GB378 (not included)  
 Ø 0 - 4 mm  
 16:1; 2.5 mm; 160 g  
 consisting parts:  
 GA062R key



**GB377R** **GB674R**  
**mini-Line heavy duty drill  
 attachment**  
 Jacobs chuck; suitable spray nozzle  
 GB378 (not included)  
 Ø 0 - 6.5 mm  
 36:1; 2.5 mm; 220 g  
 consisting parts:  
 GA031R key



**GB389R** **GB674R**  
**mini-Line drill attachment**  
 with quick coupling for tools  
 with hexagonal shank; suitable  
 spray nozzle GB378 (not included)  
 36:1; 2.5 mm; 145 g



**GB373R** **GB673R**  
**mini-Line angled drill attachment**  
 for tools with dental shank  
 8:1; 91 g





**GB398R** **GB674R**  
**mini-Line K-wire attachment**  
for use with GD684;  
for K-wires from 0.6 to 2.5 mm  
16:1; 190 g



**GB390R** **GB673R**  
**mini-Line sagittal saw attachment**  
1:1;  $\sphericalangle$  5°; 100 g



**GB392R** **GB674R**  
**mini-Line transversal saw attachment**  
1:1;  $\sphericalangle$  10°; 140 g



**GB374R** **GB673R**  
**mini-Line angled K-wire attachment**  
for use with straight mini motors;  
for K-wires from 0.6 to 1.6 mm  
17:1; 120 g



**GB391R** **GB673R**  
**mini-Line reciprocating saw attachment**  
1:1;  $\updownarrow$  2.1 mm; 100 g



**GA187R** **GB673R**  
**micro-Line adaptor**  
handpiece: micro;  
motor: mini

# Accessories

## Accessories for electric motors



**GA411**  
**microspeed® uni mobile stand**  
adjustable height  
┆ 1200 - 1500 mm



**GA415**  
**Mobile stand**  
for Elan®, microspeed® EC and  
Microtron® devices; adjustable  
height  
┆ 1200 - 1500 mm



**GD416M**  
**Mobile stand**  
for AESCULAP control units  
┆ 1320 mm  
consisting parts:  
GD414R



**GD421**  
**microspeed® uni sterile shield**  
for GD416M and GA411; for sterile  
drapes GA414

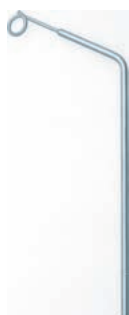

**GD412804**  
**Bottle holder**



**GA414**  
**Sterile disposable drape**  
for GD417, GA419 and GD421  
📦 package of 50 pieces



**TE780**

**Power cord Europe; black**

🌀 1.5 m; 

**TE730**

**Power cord Europe; black**

🌀 5.0 m; 

**TE734**

**Power cord UK; black**

🌀 5.0 m; 

**TE735**

**Power cord USA, Canada, Japan; grey**

🌀 5.0 m; 

Accessories

Acces-

Acces-

Acces-

Acces-

Acces-

# Accessories

## Wall outlet



AESCULAP Dräger

## Motor inlet



small

## Air hoses

**GA505R**

**GB564R**

**Air hose**

5.0 m; Latex

**GA513R**

**GB564R**

**Air hose**

3.0 m; Latex

## Wall outlet



AESCULAP Dräger

## Motor inlet



small

**GA523R**

**GB564R**

**Air hose**

(for irrigation pump GA530)

2.3 m; Latex

## Wall outlet

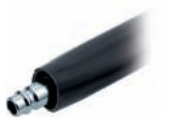

DIN

## Motor inlet



small

**GA507R**

**GB576R**

**Air hose**

5.0 m; Latex

Wall outlet

Motor inlet



Schrader with diffusor



small

**GA506R** **GB575R**

**Air hose**

5.0 m;

Wall outlet

Motor inlet



AESCULAP Dräger



large

**GA464** **GB463R**

**Air hose**

3.0 m;

**GA466** **GB463R**

**Air hose**

5.0 m;

**GA460** **GB463R**

**Air hose, spiral type**

3.0 m;

Recommended pressure for all pneumatic AESCULAP Systems is 6 - 10 bar, 85 - 145 psi  
Motor connection small fits: GA502, GA508R, GA519, GA520R, GA529, GA551, GA552, GA553, GA554, GA740R, GA741R, GA742R  
Motor connection large fits: GA200, GA430, GA437, GA440, GA521, GA530

Acces-

Acces-

Acces-

Acces-

Acces-

Accessories

# Accessories

## Wall outlet



DIN

## Motor inlet



large

### GA463

Air hose

3.0 m;

### GA465

Air hose

5.0 m;

## Wall outlet



DIN with diffusor

## Motor inlet



large

### GA461

Air hose

3.0 m;

## Wall outlet



Schrader with diffusor

## Motor inlet



large

### GA468

Air hose

5.0 m;

### GB480R

Recommended pressure for all pneumatic AESCULAP Systems is 6 - 10 bar, 85 - 145 psi  
 Motor connection small fits: GA502, GA508R, GA519, GA520R, GA529, GA551, GA552, GA553, GA554, GA740R, GA741R, GA742R  
 Motor connection large fits: GA200, GA430, GA437, GA440, GA521, GA530

### Wall outlet



AESCULAP Dräger

### Motor inlet



AESCULAP Dräger

### Extension Hoses

#### GA194

##### Extension hose

3.0 m; 

#### GA195

##### Extension hose

5.0 m; 

### Wall outlet



DIN

### Motor inlet



DIN

#### GA087

##### Extension hose

5.0 m; 

### Pneumatic Accessories



#### GA521

##### Foot control

for pneumatic systems  
air inlet: large  
air outlet: AESUCLAP Dräger



#### GA099

##### Air pressure reducer

air pressure reducer with DIN quick lock coupling; for compressed air cylinders acc. to DIN477 G5/8" AG; air inlet 100-200bar / 2130-2840psi  
consisting parts:  
GA088C DIN quick lock coupler

# Accessories



**GA088C**

**Quick lock coupler**  
for air pressure reducer GA099;  
for DIN system



**GA091C**

**Quick lock coupler**  
for french system



**GA508R**

**Angled hose adaptor**  
for all small Aesculap motors



**GA206R**

**Adaptor for pneumatic systems**  
AESCULAP motor large - Synthes  
air hoses



**GA208**

**GB474R**

**Adaptor for pneumatic systems**  
Synthes motor - air hose with  
Aesculap motor connector large



## Irrigation



### GA530

**Irrigation pump**  
for pneumatic systems; to be used with tubing set GA391SU and GA526P (not included)  
pump flow 0- 80 ml/min  
100-240 V AC, 50/60Hz;  
305 x 305 x 135 mm; 5.500 g  
consisting parts:  
GD412804 bottle holder



### GA526P

**Fixation clips**  
for combining tubing set GA391SU with pneumatic motors  
 package of 8 pieces



### GA391SU

**Tubing Set**  
complete;  
including adapter for spray nozzles and punch for irrigation bottle;  
for microspeed® uni, Microspeed® EC, Microtron® EC, Elan® (micro and mini cable only);  
HiLAN® in connection with GA526P  
 package of 10 pieces



### GA392SU

**Tubing set with Y-Adaptor**  
complete;  
including adaptor for spray nozzles and punch for irrigation bottle;  
for microspeed® uni  
 package of 10 pieces

## Adaptor



### GB421R

### GB467R

**Hudson adaptor**  
tool: Hudson;  
motor: Harris  
 3.8 mm



### GB422R

### GB467R

**AO large adaptor**  
tool: AO large;  
motor: Harris  
 3.8 mm

# Accessories



**GB423R** **GB467R**

**DIN adaptor**  
tool: DIN;  
motor: Harris  
3.8 mm



**GB425R** **GB467R**

**Zimmer/Hudson adaptor**  
tool: Zimmer/Hudson;  
motor: Harris  
3.8 mm



**GB426R** **GB467R**

**Jacobs chuck**  
tool: Jacobs;  
motor: Harris  
Ø 0 - 6,5 mm  
3.8 mm



**GB628R**

**Synthes DHS/DCS adaptor**  
tool: Synthes DHS/DCS;  
motor: AO large  
4.2 mm



**GB182R** **GB690R**

**Harris adaptor**  
tool: Harris;  
motor: Hudson  
not canulated



**GB184R** **GB690R**

**Harris adaptor**  
tool: Harris;  
motor: AO large  
3.5 mm



**GB178R** **GB690R**

**Harris adaptor**

tool: Harris;  
motor: DIN

3.5 mm



**XF457R** **GB690R**

**DIN adaptor**

tool: DIN;  
motor: AO large

3.8 mm



**GB007R** **GB690R**

**AO large adaptor**

tool: AO large;  
motor: DIN

4.0 mm



**GB187R** **GB690R**

**Harris adaptor**

tool: Harris;  
motor: triangle

3.5 mm



**GA187R** **GB673R**

**micro-Line adaptor**

handpiece: micro;  
motor: mini

Accessories

Acces-

Acces-

Acces-

Acces-

Acces-

# Accessories

## Keys



**GA186209** **GB690R**

**Key**  
for mini-coupling  
suitable for GA186, GA551, GA552,  
GA647, GD674, GD684



**TE472** **GB690R**

**Ring spanner**  
for Aesculap star coupling



**GB020R** **GB690R**

**Allen Key**  
width across flats 3 mm  
suitable for GB101, GB102R,  
GB115R, GB121R, GB125R,  
GB210R, GB230R, GB377R



**GA062R** **GB690R**

**Key**  
for small 4mm Jacobs chuck  
suitable for GB108R, GB166R,  
GB181R, GB222R, GB383R,  
GB415R



**GA031R** **GB690R**

**Key**  
for large 6,5mm Jacobs chuck;  
with integrated Allen key, width  
across flats 3,5mm  
suitable for GB223R, GB386R,  
GB416R, GB426R, GB424R,  
GB177R, GB638R



**GD372206**

**Key**  
width across flats 6,0 mm  
suitable for GD307

## Skin graft mesher



**BA720R** 

### Skin graft mesher

for use in combination with skin carriers BA721 (1:1,5) / BA722 (1:3) / BA723 (1:6)

150 x 195 x 105 mm;  4.600 g

consisting parts:  
BA725R cutting roller  
BA726R ratchet wrench

**BA725R**

### Cutting roller



## Cement injection



**GB141**

### Cement syringe

for cement injector GB171N; with special injection tubing  
50 ml

 package of 10 pieces

**GB171N**

### Cement injector

for disposable syringe GB141



## Bone mill



**GB040**

### Bone mill

for use with motor or crank handle  
consisting parts:  
GB042R crushing drum

**GB042R**

### Crushing drum

standard; Harris shaft; section of the produced bone chip  
0.7 x 3 mm



# Accessories



**GB043R**

**Crushing drum**  
fine; Harris shaft; section of the  
produced bone chip 0.7 x 2 mm



**GB044R**

**Crushing drum**  
coars; Harris shaft; section of the  
produced bone chip 0.7 x 4 mm



**GB041R**

**Crank handle for GB040**



**GB046**

**Insert for GB040**  
for small bone grafts

# Processing

## Sterilit<sup>®</sup> Power Systems

## Eccos<sup>®</sup>

- Eccos<sup>®</sup> for Power Systems
- Eccos<sup>®</sup> for handpieces
- Eccos<sup>®</sup> for accessories
- Eccos<sup>®</sup> sets

# Sterilit® Power Systems

## Sterilit® Power Systems



**GB600**

**Sterilit® Power Systems**

300 ml

 package of 6 pieces



**GB600810**

**Sterilit® Power Systems spray**

**adaptor**

for micro-Line



**GB600820**

**Sterilit® Power Systems spray**

**adaptor**

for HiLAN®, HiLAN® XS, Hi-Line,  
Hi-Line XS, Microspeed® EC,  
microspeed® uni, microLAN,  
miniLAN



**GB600830**

**Sterilit® Power Systems spray**

**adaptor**

for mini-Line



**GB600840**

**Sterilit® Power Systems spray**

**adaptor**

for Acculan® 3Ti



**GB600870**

**Sterilit® Power Systems spray**

**adaptor**

for microspeed® uni XS





**GA059**  
**Sterilit® drip lubricator**  
50 ml

Processing

### **The solution for storage and mechanical reprocessing of your Aesculap Power Systems.**

Basic requirements for mechanical reprocessing in combination with the Eccos® system:

- > A suitable cleaner must be used (pH < 11 for Aluminum components)
- > The temperature in the cleaning cycle must not exceed 55°C
- > Clean for at least 3 minutes
- > Apply intermediate rinse for at least 1 minute
- > Carry out intensive final rinse with distilled, demineralised or fully desalinated water
- > Only Thermal disinfection: 5 minutes rinse at 93°C with distilled, demineralised or fully desalinated water
- > Complete the programme with a drying phase of at least 10 minutes at a temperature of not more than 120°

microspeed® uni/microspeed® arthro



**GB579R**  
Eccos® fixation  
for GD684  
56 mm



**GB578R**  
Eccos® fixation  
for GD674, GD676, GD678  
56 mm



**GB689R**  
Eccos® fixation  
for GD672, GD673  
56 mm

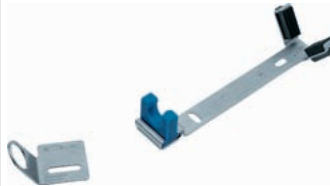

**GB580R**  
Eccos® fixation  
for GD682, GD681  
56 mm



**GB587R**  
Eccos® fixation  
for GD685  
56 mm



**GB586R**  
Eccos® fixation  
for GD675  
56 mm



Processing

# Eccos<sup>®</sup> for Power Systems

## Elan<sup>®</sup> EC

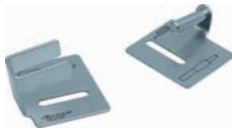

### GB680R

**Eccos<sup>®</sup> fixation**  
for GA173, GA176

 56 mm



## HiLAN<sup>®</sup> XS, HiLAN<sup>®</sup>



### GB577R

**Eccos<sup>®</sup> fixation**  
for small Aesculap motors with  
mounted angled hose adaptor  
GA508R

 56 mm

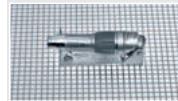

### GB559R

**Eccos<sup>®</sup> fixation**  
for GA519, GA529

 56 mm

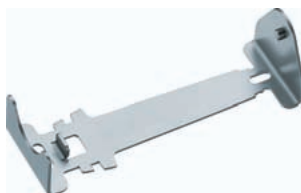
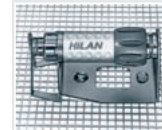

### GB609R

**Eccos<sup>®</sup> fixation**  
for GA742R, GA522R

 56 mm



## microLAN®



### GB685R

#### Eccos® fixation

for GA502, GA553, GA554, GD657, GD658

 56 mm



## Acculan® 3Ti



### GB495R

#### Eccos® fixation

for GA671, GA672, GA673, GA674

 106 mm



### GB497R

#### Eccos® fixation

for GB630R, GB635R, GB636R, GB638R, GB643R, GB644R, GB645R, GB654R, GB655R, GB656R, GB660R

 106 mm



### GB496R

#### Eccos® fixation

for GB630R, GB635R, GB636R, GB638R, GB643R, GB644R, GB645R, GB654R, GB655R, GB656R, GB660R

 106 mm



### GB487R

#### Eccos® fixation

for GA675

 56 mm



Processing

# Eccos<sup>®</sup> for Power Systems



**GB488R**

**Eccos<sup>®</sup> fixation**  
for GA678

 76 mm

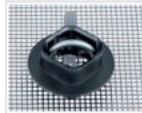

**GB489R**

**Eccos<sup>®</sup> fixation**  
for GA614, GA644, GA679

 106 mm



**GB498R**

**Eccos<sup>®</sup> fixation**  
for GA668, GA670

 106 mm



## Hi-Line XS



### GB611R

**Eccos® fixation for 1 Hi-Line XS handpiece**  
for GB740R, GB751R, GB752R, GB753R, GB756R, GB757R, GB758R, GB771R, GB772R, GB773R

 56 mm



### GB614R

**Eccos® fixation for 3 Hi-Line XS handpieces**  
for GB740R, GB751R, GB752R, GB753R, GB756R, GB757R, GB758R, GB771R, GB772R, GB773R

 56 mm

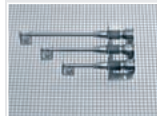

### GB613R

**Eccos® fixation**  
for 13 burrs of the Hi-Line XS, Hi-Line or 2,35 mm shaft range

 36 mm

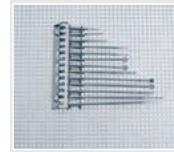

### GB615R

**Eccos® fixation**  
for GB741R - GB748R

 56 mm

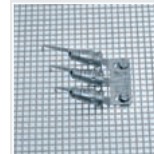

## micro-Line



### GB681R

**Eccos® fixation**  
for GB109, GB110, GB111, GB112, GB113, GB114R, GB291R, GB292R, GD305, GD307, GB310, GD450M, GD451M, GD452M, GD455M, GD456M, GD457M, GD465M, GD466M, GD467M

 56 mm



### GB686R

**Eccos® fixation**  
for GB266, GB298, GB436R

 56 mm



# Eccos<sup>®</sup> for handpieces



## GB682R

### Eccos<sup>®</sup> fixation

for GB128R, GB129, GB130R,  
GB166R, GB169R, GB200, GB231R,  
GB265R, GB267R, GB268R, GB280,  
GB801R

 76 mm

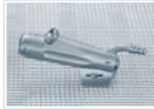

## mini-Line



## GB673R

### Eccos<sup>®</sup> fixation

for GB373R, GB374R, GB376R,  
GB377R, GB379R, GB380R,  
GB381R, GB382R, GB383R,  
GB386R, GB390R, GB391R

 56 mm



## GB674R

### Eccos<sup>®</sup> fixation

for GB385R, GB388R, GB389R,  
GB392R, GB397R, GB398R

 56 mm





## Skin graft mesher

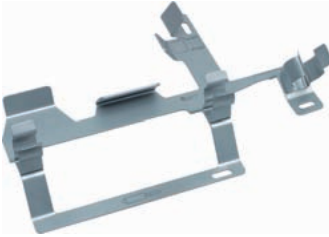

**GB688R**

**Eccos® fixation**  
for BA720R

106 mm

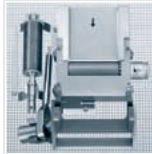

## Accessories



**GB564R**

**Eccos® fixation**  
for GA505R, GA513R, GA523R

56 mm



**GB463R**

**Eccos® fixation**  
for GA460, GA464, GA466

76 mm



**GB575R**

**Eccos® fixation**  
for GA506R

76 mm



**GB576R**

**Eccos® fixation**  
for GA507R

56 mm



Processing

# Eccos® for accessories



## GB467R

**Eccos® fixation**  
for GB421R, GB422R, GB423R,  
GB424R, GB425R  
56 mm



## GB474R

**Eccos® fixation**  
for GA206R  
56 mm



## GB480R

**Eccos® fixation**  
for GA468R  
76 mm

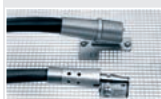

## GB481R

**Eccos® fixation**  
for saw blades and other  
accessories  
56 mm

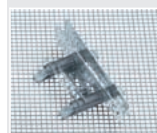

## GB572R

**Eccos® fixation**  
for GB300R - GB308R  
56 mm



## GB690R

**Eccos® fixation**  
for GB173R, GB119, GB154,  
GB194, GB628R, GA031201,  
GB424201, GA437224, GB009C  
36 mm





**GB584R**

**Eccos® fixation**

for Aesculap shaver tips with diam.  
4.5; 5.5 and 6.0 mm

 56 mm

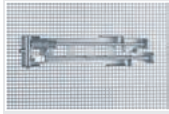

**GB473**

**Eccos® mounting set**



**GB585R**

**Eccos® fixation**

for Aesculap shaver tips with diam.  
3.7 mm

 56 mm

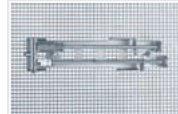

Processing

# Eccos<sup>®</sup> sets

## Acculan<sup>®</sup> 3Ti

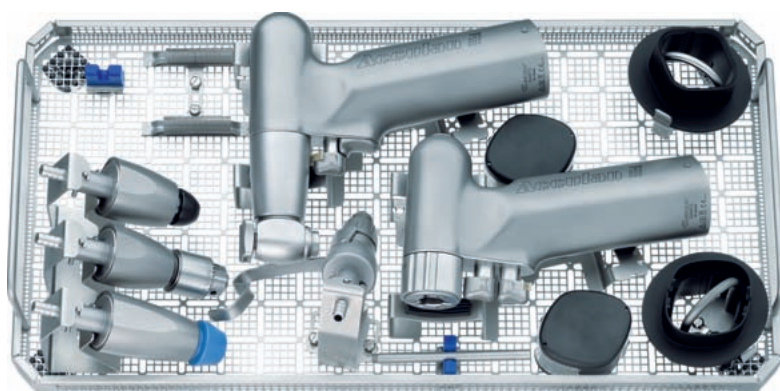

### GB243R

#### Eccos<sup>®</sup> Set for 2 Acculan<sup>®</sup> 3Ti machines

 106 mm

consisting parts:

GB243800  
GB481R  
GB487R  
GB488R  
GB495R  
GB496R  
GB497R  
GB690R

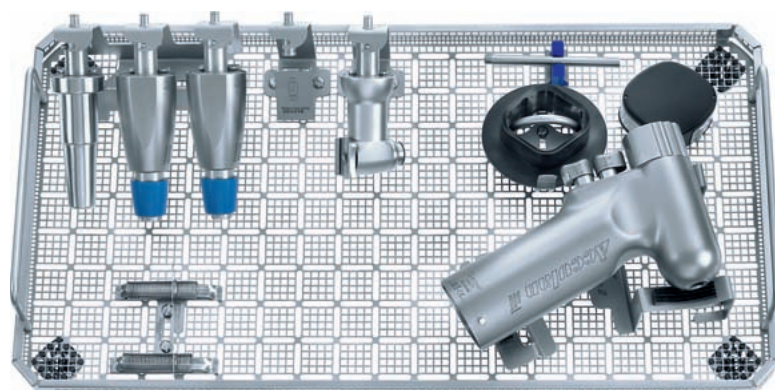

### GB244R

#### Eccos<sup>®</sup> Set for 1 Acculan<sup>®</sup> 3Ti machine

 106 mm

consisting parts:

GB243800  
GB481R  
GB487R  
GB488R  
GB495R  
GB496R  
GB497R  
GB690R

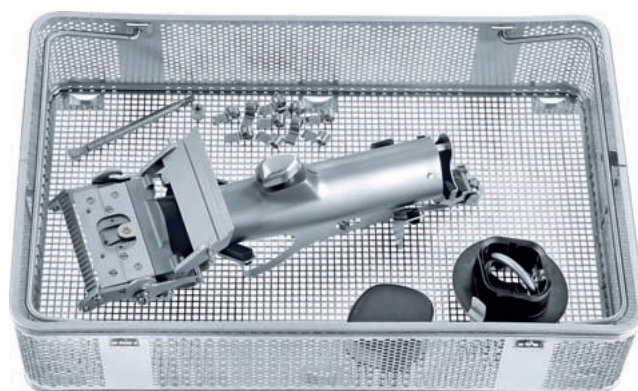

### GB256R

#### Eccos<sup>®</sup> Set for Acculan<sup>®</sup> 3Ti dermatome

 106 mm

consisting parts:

GB487R  
GB488R  
GB498R  
JC254R

## microspeed® uni

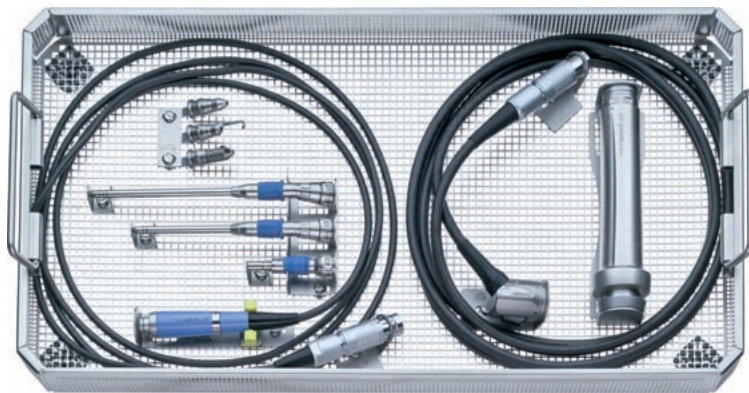

### GB255R

#### Eccos® Set for microspeed® uni Neurosurgery

 56 mm

consisting parts:

GB586R  
GB587R  
GB614R  
GB615R  
GB689R  
JF212R

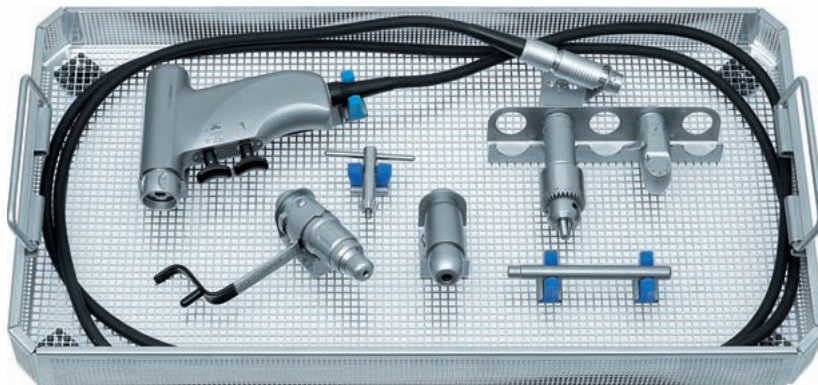

### GB254R

#### Eccos® Set for microspeed® uni small bone surgery

 56 mm

consisting parts:

GB579R  
GB673R  
GB674R  
GB690R  
JF212R

## HiLAN® XS

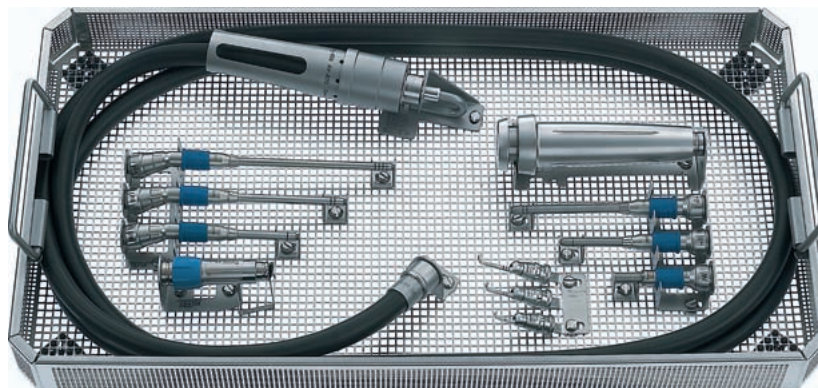

### GB252R

#### Eccos® Set for HiLAN® XS

 56 mm

consisting parts:

GB561R  
GB564R  
GB610R  
GB614R  
GB615R  
JF213R



# Index/Signs and Symbols

# Index by reference numbers















BA720R	53	GA674	25	GB265R	39	GB600840	56
BA725R	53	GA675	26	GB268R	39	GB600870	56
		GA676	26	GB292	39	GB609R	60
GA031R	52	GA677	25	GB373R	40	GB610R	
GA059	57	GA678	26	GB374R	41	GB611R	63
GA062R	52	GA679	26	GB376R	40	GB613R	63
GA087	47	GA740R	19	GB377R	40	GB614R	63
GA088C	48	GA741R	19	GB382R	40	GB615R	63
GA091C	48	GA742R	19	GB383R	40	GB628R	50
GA099	47	GA830	17	GB389R	40	GB630R	23
GA173	17	GA835	17	GB390R	41	GB635R	23
GA176	17			GB391R	41	GB636R	24
GA186209	52	GB007R	51	GB392R	41	GB638R	23
GA187R	41,51	GB020R	52	GB398R	41	GB643R	23
GA188	17	GB040	53	GB421R	49	GB645R	24
GA194	47	GB041R	54	GB422R	49	GB654R	24
GA195	47	GB042R	53	GB423R	50	GB655R	24
GA206R	48	GB043R	54	GB425R	50	GB656R	24
GA208	48	GB044R	54	GB426R	50	GB660R	24
GA391SU	49	GB046	54	GB436R	25	GB673R	64
GA392SU	49	GB106R	39	GB463R	65	GB674R	64
GA411	42	GB109	34	GB467R	66	GB680R	60
GA414	42	GB111	36	GB473	67	GB681R	63
GA415	42	GB113	36	GB474R	66	GB682R	64
GA460	45	GB114R	36	GB480R	66	GB685R	61
GA461	46	GB119	36	GB481R	66	GB686R	63
GA463	46	GB128R	37	GB487R	61	GB688R	65
GA464	45	GB129	37	GB488R	62	GB689R	59
GA465	46	GB130R	37	GB489R	62	GB690R	66
GA466	45	GB141	53	GB495R	61	GB740R	31
GA468	46	GB164	36	GB496R	61	GB741R	31
GA505R	44	GB169R	38	GB497R	61	GB742R	31
GA506R	45	GB171N	53	GB498R	62	GB743R	31
GA507R	44	GB173	36	GB559R	60	GB744R	32
GA508R	48	GB178R	51	GB564R	65	GB745R	32
GA513R	44	GB182R	50	GB572R	66	GB746R	31
GA519	19	GB184R	50	GB575R	65	GB747R	31
GA521	47	GB187R	51	GB576R	65	GB748R	32
GA523R	44	GB200	37	GB577R	60	GB751R	28
GA526P	49	GB222	38	GB578R	59	GB752R	28
GA529	19	GB223	38	GB579R	59	GB753R	28
GA530	49	GB224	38	GB580R	59	GB756R	29
GA553	20	GB227R	38	GB584R	67	GB757R	29
GA554	20	GB231R	39	GB585R	67	GB758R	29
GA666	26	GB243R	68	GB586R	59	GB771R	30
GA668	25	GB244R	68	GB587R	59	GB772R	30
GA670	25	GB252R	69	GB600	56	GB773R	30
GA671	23	GB254R	69	GB600810	56	GB865	38
GA672	23	GB255R	69	GB600820	56		
GA673	25	GB256R	68	GB600830	56	GD305	37





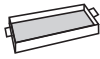

# Signs and symbols

	Article code Eccos® fixation
	Forward / reverse drive
	Forward drive
	Oscillation frequency
	Oscillation angle
	Stroke
	Cannulation
	Cable length
	Weight
	Sterile
	Single use
	Latex free
	Packaging Unit
	Required height of tray
	Suitable handpiece-line

